

VER : 13-1.0

LOCSTAR TECHNOLOGY CO., LTD

Add:20#, Shuitian Road, Tongle Community,

Longgang District, Shenzhen,China. Zip Code:518116

Tel:+86-755-84893474 Fax:+86-755-28072922

Mail:locstar@locstar.com locstar@vip.163.com

Website:www.locstar.com locstar.en.alibaba.com



User Manual

Manual of Z-Wave Induction Coded Lock



Model: LS-8015-MM-Z-Wave

Z-Wave Certification No: ZC08-13100011

- Please read this manual carefully before installing
- Please safekeeping of this handbook to prepare for inspection

Content

I. Product Introduction	01
1. Product Introduction	01
2. Product Performance Parameters	03
3. Packing List	04
II. Installation Guide	06
1. Installation Condition	06
1.1. Door Thickness Requirement	06
1.2. Confirmation for Door Swing Direction	06
2. Installation Tools	06
3. Drilling Template	07
4. Installation Steps	08
III. Operation Guide	10
1. Key Instruction	10
2. Password Quantity Distribution	10
3. Unlock Mode	10
4. Instruction for Door Lock Setting	10
4.1. Modify the Programming Code	10
4.2. Add User Password	11
4.3. Modify User Password	11
4.4. Delete Single User Password	12
4.5. Delete All User Passwords	12
4.6. Enable/Disable Button Voice	13
4.7. Z-WAVE Gateway Enroll/Uenroll	13
5. Door Opening and Closing Instruction	13
5.1. User Password Unlocking	13
5.2. Programming Code Unlocking In Emergency	14
5.3. Wireless Unlocking	14
6. Reset	14
7. Malfunction Prevention Function	15
8. Low Voltage Alarm and Battery Replacing Method	15
8.1. Low Voltage Alarm	15
8.2. Battery Replacing Method	15
8.3. Mechanical Keys Usage	15
9. Z-Wave Technical Specification	16
V. After-sale Service	18
Appendix I	19
Appendix II	20

I. Product Introduction

1.Product Introduction

1.1、LS-8015-MM-Z-Wave-DS

	Size(Outside) (mm:W*H*D)	69.3 × 156.7 × 85.8
	Material	Zinc alloy
	Weight	2.3Kg

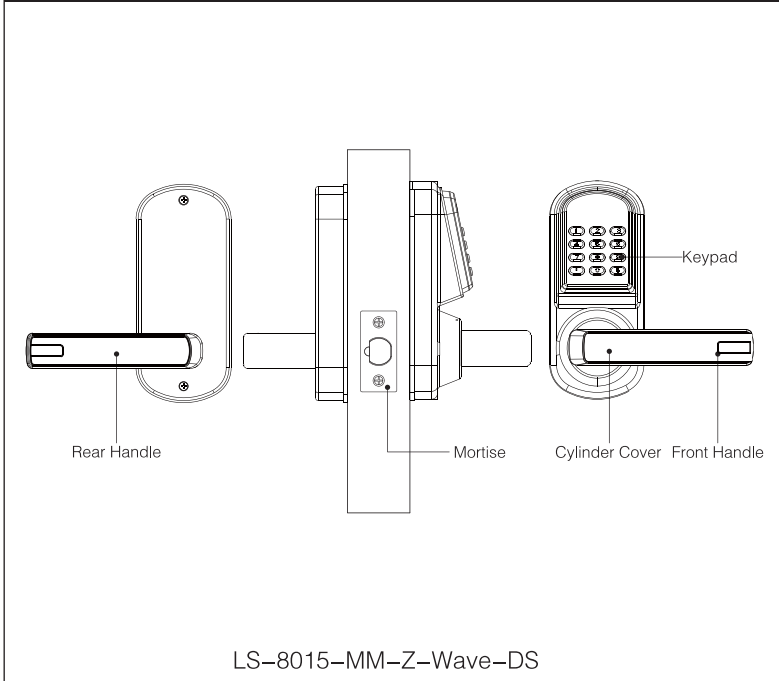

1.2、LS-8015-MM-Z-Wave-9500

	Size(Outside) (mm:W*H*D)	69.3 × 156.7 × 85.8
	Material	Zinc alloy
	Weight	2.3Kg

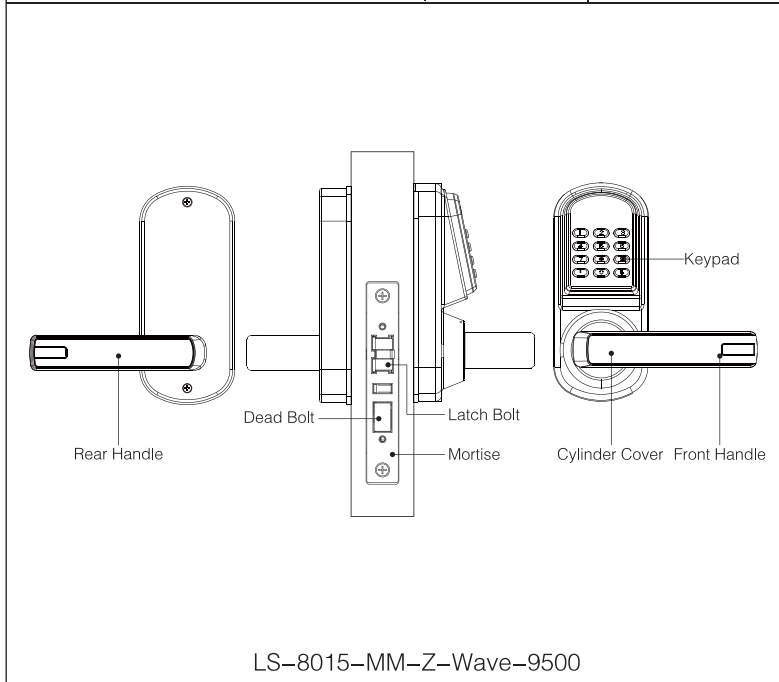



3、Product Performance Parameters



Description	Parametric Description
Open Mode	Code、mechanical key、 wireless
Identification Time	<1s
False Reject Rate	≤0.01%
False Identification Rate	≤0.0001%
User Capacity	20
Working Voltage	5 alkaline batteries for 4pcs AA(DC4.8 ~ 6.5V)
Deficient Voltage Alarm	5.0V (+/-0.2V)
Holing Current	30 ~ 450uA
Working Temperature	-20°C ~ 55°C
Storage Temperature	-30°C ~ 70°C
Mean Free Failure Time	≥25,000h

4. Packing List

4.1. LS-8015-MM-Z-Wave-DS Packing List

 <p>1. Front panel</p>	 <p>2. Rear panel</p>	 <p>3. Front and rear panel waterproof rubber gaskets(2pcs)</p>
 <p>4. Single latch mortise</p>	 <p>5. Dust Boot</p>	 <p>6. Square Shaft</p>
 <p>7. Spanner</p>	 <p>8. Strike Plate</p>	 <p>9. Self-tapping Screw</p>
 <p>10. Position Pin</p>	 <p>11. Fixed Screw</p>	 <p>12. Mechanical Key</p>
 <p>13. User Manual</p>	 <p>14. Single Latch Mortise Drilling Figure</p>	

4.2.LS-8015-MM-Z-Wave-9500 Packing List

 <p>1.Front panel</p>	 <p>2.Rear panel</p>	 <p>3.Front and Rear panel Waterproof Rubber Gaskets(2pcs)</p>
 <p>4.Five latch mortise</p>	 <p>5.Dust Boot</p>	 <p>6.Square Shaft</p>
 <p>7.Spanner</p>	 <p>8.Strike Plate</p>	 <p>9.Self-tapping Screw</p>
 <p>10.Position Pin</p>	 <p>11.Fixed Screw</p>	 <p>12.Mechanical Key</p>
 <p>13.User Manual</p>	 <p>14.Five Latch Mortise Drilling Figure</p>	

II. Installation Guide

1、 Installation Conditions

1.1. Requirement of Door Thickness

- Lock edging $\geq 110\text{mm}$ (doors with different thickness)
- $35\text{mm} \leq \text{door thickness} \leq 60\text{mm}$ (if door thickness $\geq 60\text{mm}$, it needs customized parts)

1.2. Confirmation for Door- opening Direction

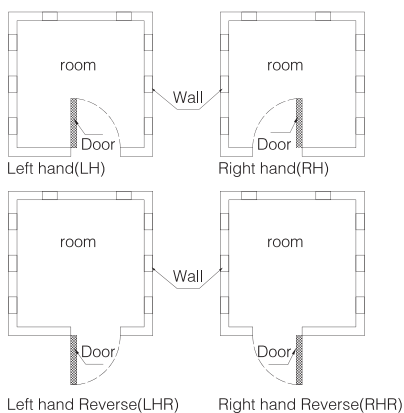

2、 Installation Tool

		
1.Pencil	2.Tape	3.Angle Square
		
4.Manual Electric Drill	5.Drill	6.Hammer
		
7. Art Knife	8.Screwdriver	9.Chisel

3、Drilling figure

3.1、Single latch mortise drilling figure

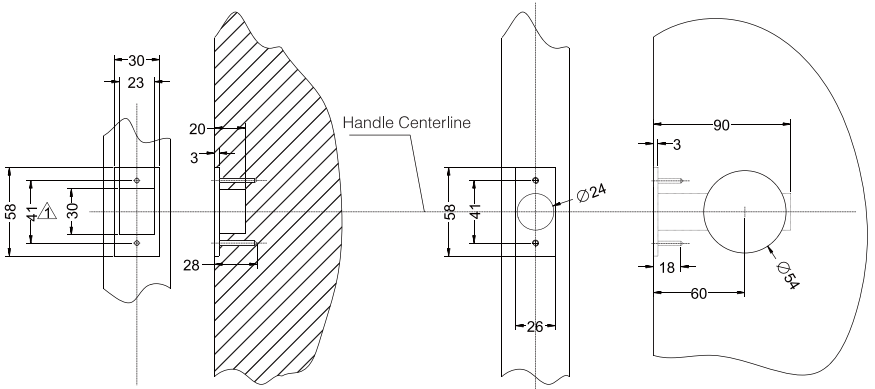

3.2、Five latch mortise drilling figure

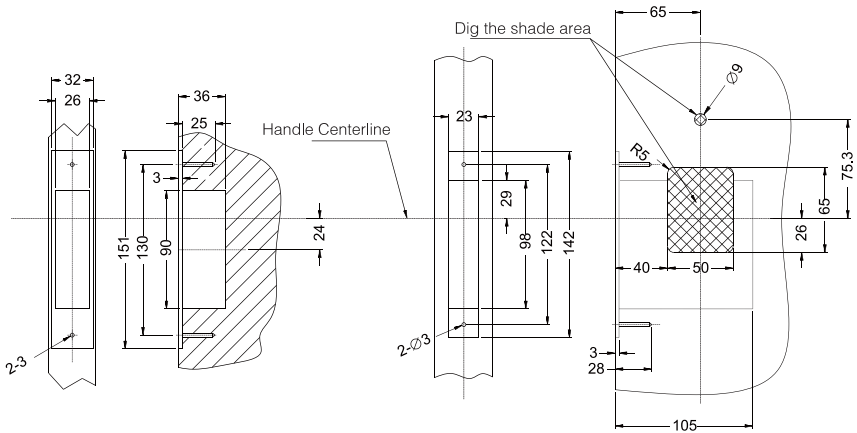

4. Installation Steps

4.1. Installation Steps of Lock With Five Latch Mortise

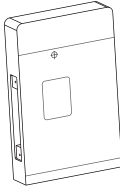
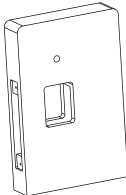
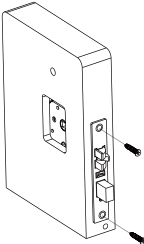
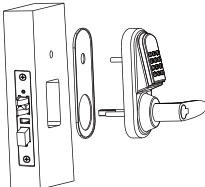
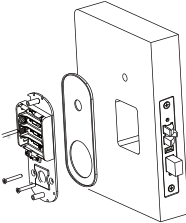
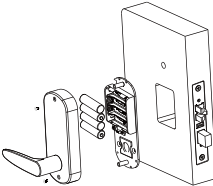
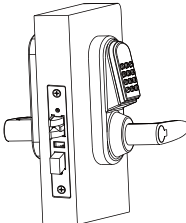
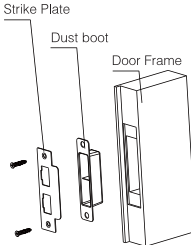
 <p>I. Draw lines 1. Draw a horizontal center line at place 1m above the ground both inside and outside the door. 2. Fold the template, align the handle center line of drilling template and horizontal line on the door, and then draw the line on the front and side door according to the requirements of drilling template.</p>	 <p>II. Drill hole According to the drilling template, drill hole for lock panel and mortise.</p>
 <p>III. Install lock mortise Install the mortise into the mortise hole and fix with 2 screws.</p>	 <p>IV. Front panel installation 1. Insert the square shaft into the center hub. Insert the position pin into the hole on the center hub to secure the square shaft. Bend the end of position pin around the center hub to secure the pin in place. 2. Screw in and tighten the two fastener extensions into the front lock fastener posts located on both side of the center hub. Attach and tighten the upper fastener extension if needed. Note: The upper fastener extension is optional. 3. Place the front lock housing onto the door, with the rubber gasket between the door and lock housing. Feed the power plug through the hole;</p>
 <p>V. Rear panel installation 1. Attach the battery plate onto the door, with the rubber gasket between the door and battery plate. Make sure the power plug go through the hole on the plate. Secure the battery plate to front lock fastener post with 2 screws. Fasten upper fastener post</p>	 <p>VI. Battery installation Install batteries, and plug in the power cable. Secure the back lock housing onto the battery plate. Fasten with 2 screws.</p>
 <p>VII. Debug after the completion of installation 1. Turn the handle, and check the flexibility of the handle of both the front and back panel. 2. Remove the cylinder cover, insert the mechanical key and turn the key clockwise to the 90°, then turn front handle to open the door. Check whether the key can normally open the door. 3. Set the door lock according to the door lock operation guide, and then test the door lock.</p>	 <p>VIII. Door strike installation 1. Make the door closed to the door frame, then draw the location of latch and hole of door frame on the door frame. 2. Put the strike box and strike plate into the hole based on the sequences shown on the left picture, then fix the strike plate with 2 screws. 3. Check whether the latch can completely reach out after shut the door.</p>

4.2. Installation Steps of Lock With Single Latch Mortise

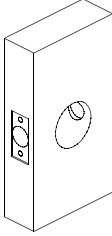
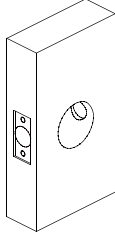
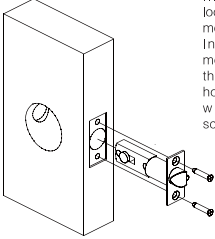
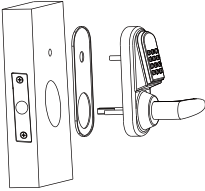
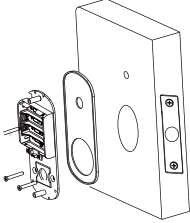
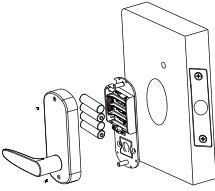
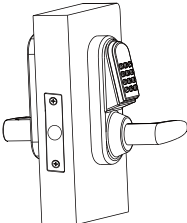
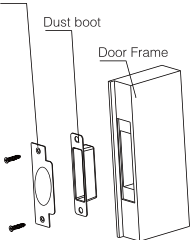
 <p>I. Draw lines 1. Draw a horizontal center line at place 1m above the ground both inside and outside the door. 2. Fold the template, align the handle center line of drilling template and horizontal line on the door, and then draw the line on the front and side door according to the requirements of drilling template.</p>	 <p>II. Drill hole According to the drilling template, drill hole for lock panel and mortise.</p>
 <p>III. Install lock mortise Install the mortise into the mortise hole and fix with 2 screws.</p>	 <p>IV. Front panel installation 1. Insert the square shaft into the center hub. Insert the position pin into the hole on the center hub to secure the square shaft. Bend the end of position pin around the center hub to secure the pin in place. 2. Screw in and tighten the two fastener extensions into the front lock fastener posts located on both side of the center hub. Attach and tighten the upper fastener extension if needed. Note: The upper fastener extension is optional. 3. Place the front lock housing onto the door, with the rubber gasket between the door and lock housing. Feed the power plug through the hole.</p>
 <p>V. Rear panel installation 1. Attach the battery plate onto the door, with the rubber gasket between the door and battery plate. Make sure the power plug go through the hole on the plate. Secure the battery plate to front lock fastener post with 2 screws. Fasten upper fastener post</p>	 <p>VI. Battery installation Install batteries, and plug in the power cable. Secure the back lock housing onto the battery plate. Fasten with 2 screws.</p>
 <p>VII. Debug after the completion of installation 1. Turn the handle, and check the flexibility of the handle of both the front and back panel. 2. Remove the cylinder cover, insert the mechanical key and turn the key clockwise to the 90°, then turn front handle to open the door. Check whether the key can normally open the door. 3. Set the door lock according to the door lock operation guide, and then test the door lock.</p>	 <p>Strike Plate Dust boot Door Frame</p> <p>VIII. Door strike installation 1. Make the door closed to the door frame, then draw the location of latch and hole of door frame on the door frame. 2. Put the strike box and strike plate into the hole based on the sequences shown on the left picture, then fix the strike plate with 2 screws. 3. Check whether the latch can completely reach out after shut the door.</p>

III Operation Guide

1、Key Instruction

- Press “1-9” buttons for codes
- Press “*” for return
- Press “#” for confirmation
- There is a reset button on back panel

2、Quantity of code

- Programming code: 1 group (default programming code: 12345678,
- User password:20 groups(6 digits) with user no.01-20

3、Unlock method

- Password, Mechanical key, Wireless

4、 Instruction for Door Lock Setting

4.1、Modify the Programming Code

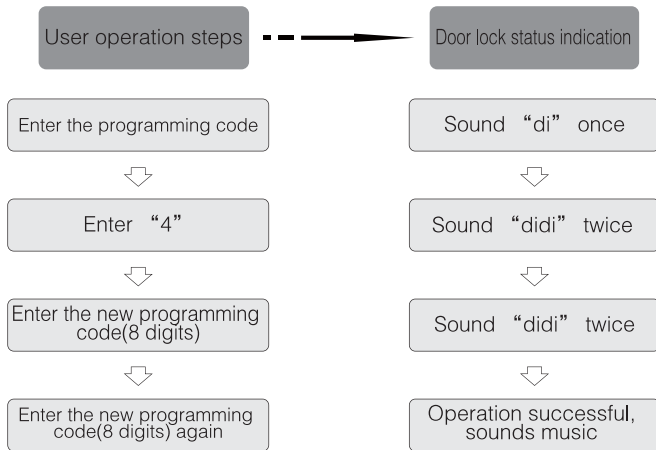

❖ Instruction:

- New programming code should be different with the default programming code.
- When modify the programming code, the first input code should be same with the second input code.

4.2. Add user password

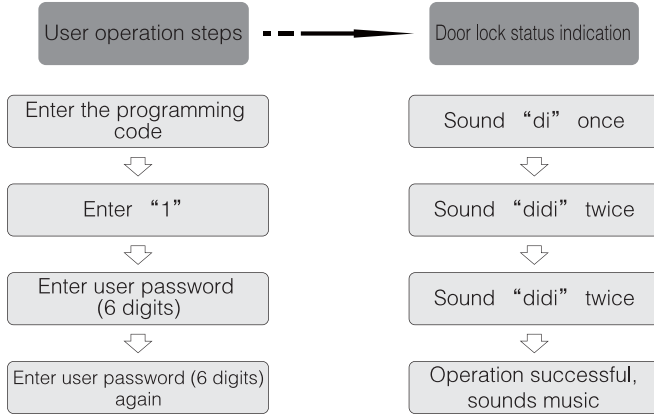

❖ Notes:

➤ If the user password has been added, it prompts user password adding fail and quit automatically.

4.3. Modify the user password

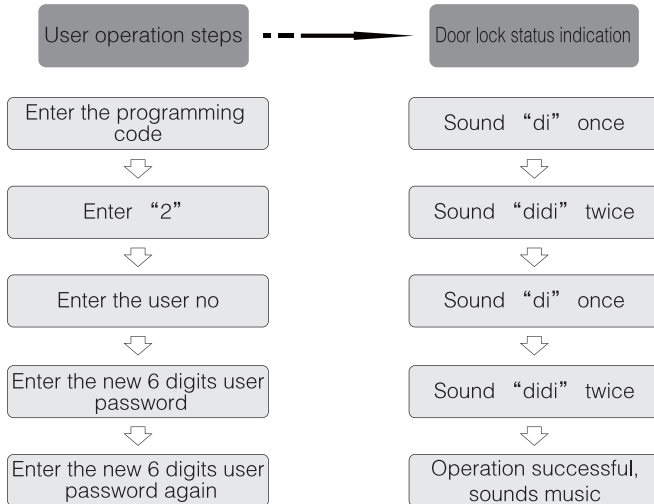

4.4、Delete single user password

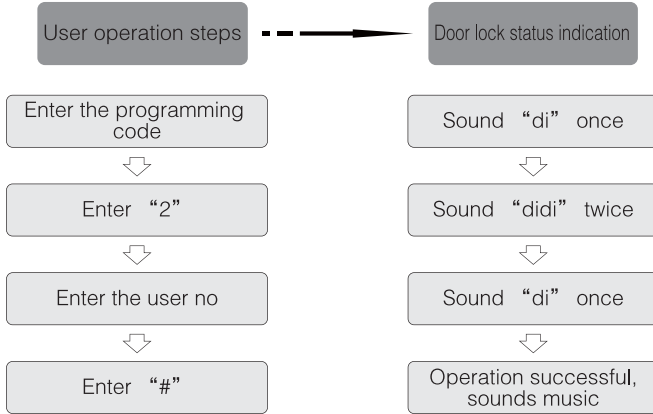

4.5、Delete all user password

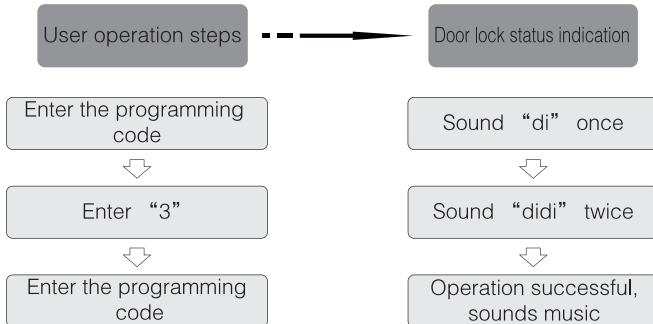

4.6、Start/Disable Key Warning Tone

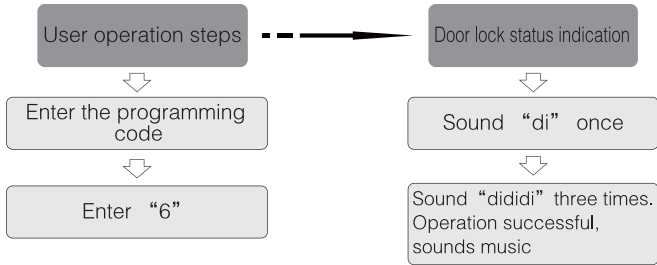

4.7、Z-WAVE Gateway enroll/ unenroll

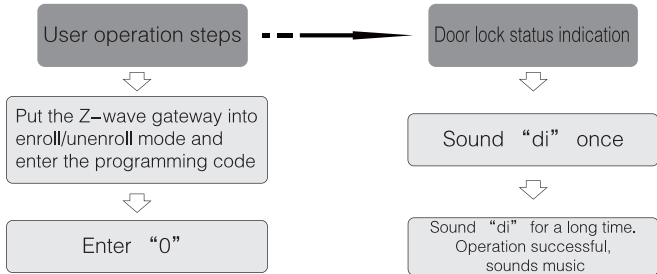

❖ Notes:
 > if the door lock has been registered on other Z-Wave gateway, please unenroll the lock firstly, then re-enroll

5、Door opening and closing instruction.

5.1、User Password Unlocking

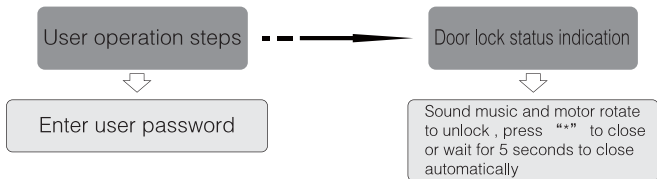

5.2、Programming Code Emergency Unlocking

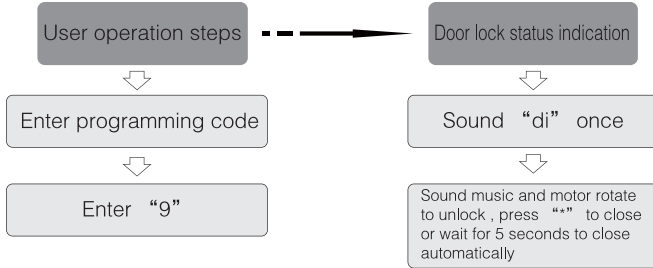

5.3、Wireless unlocking

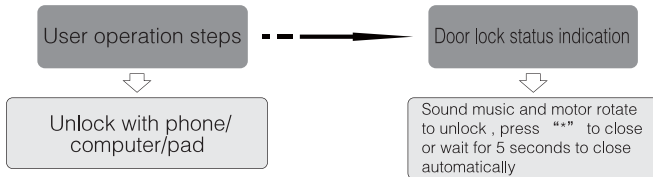

6、Reset

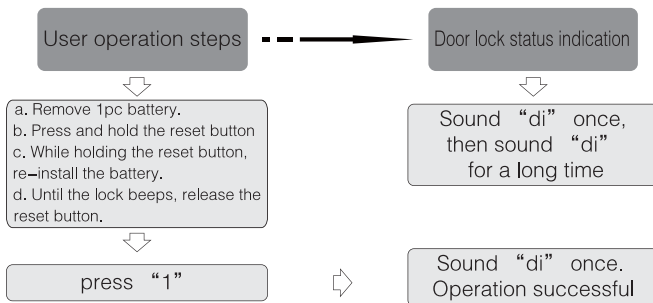

❖ Notes:

- After reset, all existing user codes and current programming code will be erased. Default Programming Code will be restored, but the enrolling of lock with gateway will not be erased.

7. Malfunction prevention functions

When 10 failed authentication attempts with unregistered code, the lock will stop operating for 5 minutes.

8. Low voltage alarm function and battery replacing Method

8.1. Low voltage alarm function

When battery power is lower than 5.0v (+/-0.2), when unlock the door, there will be alarm. After open the door, light red & flash 3 times and beep 3 times.

8.2. Battery Replacing Method

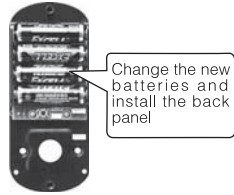

8.3. Mechanical Key



9. Z-Wave Technical Specification

Generic Device Class = GENERIC_TYPE_ENTRY_CONTROL;

Specific Device Class = SPECIFIC_TYPE_SECURE_KEYPAD_DOOR_LOCK;

FLIRS setting = APPLICATION_FREQ_LISTENING_MODE_1000ms;

The device is the process of safely enabling Z-Wave, realizing the Z-Wave security layer according to the Z-Wave agreement. The function and supporting instructions are different when they are listed into safe or unsafe nodes.

According to the Z-Wave anti-theft instruction V2 grade, the device can supports the anti-theft protection function. When the anti-theft protection enables the Z-Wave agreement, the order of supporting is only anti-theft CC.

Orders supported by the device	Including no safe nodes, NF response	Including no safe nodes, NF response, anti-theft protection ,NF response	Including safe node, NF response.	Including safe node, safe support response	Including safe node, anti-theft protection ,NF response	Including safe node, anti-theft protection, safe response support
Anti-theft	√	√		√		√
Especially for Manufacturer	√	√	√	√	√	
versions	√	√	√	√	√	
safety	√		√		√	
Application _ status	√		√	√		
Alarm	√			√		
Association	√			√		
Basic	√		√	√		
Battery	√			√		
Configuration	√			√		
Door_lock				√		
Door_lock_login	√			√		
Node_name	√			√		
Schedule_entering_lock	√			√		
Date_ parameter	√			√		
User_codes				√		

COMMAND_CLASS_APPLICATION_STATUS

The device responds request order which refused the application program, receiving the invalid orders when the original nodes are identical.

COMMAND_CLASS_ASSOCIATION

This device supports 2 kinds of contract groups, and in each group supporting 2 node maximum values. ID I is used for sending anti-social operation and alarm report. Group ID II is used for sending the order ON and Off of basic device, and the vacation mood means starting and forbidden.

COMMAND_CLASS_CONFIGURATION

The device reserves memory storage space of 225 bytes for upper layer application. The upper layer application program may visit the memory through the categories of configuration order. The default settings all always 0(0 × 00), the parameter is always 1(0 × 01), the probable value from 0 × 00 to 0 × FF of parameter is decided by upper application.

COMMAND_CLASS_DOOR_LOCK

There are 2 various relock modes in the device: automatic relocking mode (fixed cycle operation) and constant unlocking mode (constant operation). The device may configurate orders through manual or door lock. The timeout restore will start within 8s. The device set the door lock operation unchangeable and unsafe as unsafe and timeout and the device will automatically relock mode functions.

COMMAND_CLASS_NODE_NAMING

The device report nodes names will be announced after the ASC II brand name and products version are reset to factory default value.

COMMAND_CLASS_SCHEDULE_ENTRY_LOCK

The device doesn't support the function of daylight saving and ignores DST offset of offset setting order of appendix table input time. Device supports the continuous time of appendix table entering lock.

Reset order from 0 to 168(=7 × 24) maximum lasting time.

COMMAND_CLASS_USER_CODE

The device user code restores 6 digits. If user code is not 6 digits, it will ignore user code setting order.

IV、 After sales service

1、Routine maintenance

Please keep your fingers clean when use the product.

Avoiding contact with corrosive substances or liquids so as to affect the appearance of the body.

- Strictly prohibit hard objects to knock fingerprint reading head surface to prevent damage and affect the normal use.
- If the fingerprint capture window surface is dirty that may affect the normal use of locks. Please keep window clean everyday.
- Safekeeping of the keys, when the fingerprint or password can not open door, please use the keys.
- Please change battery when Low-voltage alarming, so as not to affect the normal use of locks.
- Lock surface can be used furniture polish wax to keep glossy.

Do not use water or alcohol to clean fingerprint capture window. Only permit to

- use soft cloth to sweat stains of the collector window.
-

2、After-sale services

Product warranty for free in 1 year. The product turns to quality problems, it shall acquire free warranty after installed and inspected by the two sides. But the man-made factors (such as the improper use, man-made damage, etc.), force majeure cause accidental damage, it does not belong to the scope, and maintenance required charges for the cost of fees. User-demolition-off or without the company agree to non-designated repair sites for door locks will not gain warranty.

Life maintenance. Collect cost price after 1 year.

Shenzhen Locstar Technology Co., Ltd. can provide you with emergency services and door-to-door service according to the selected services.

- If it fails in use, please contact with customer service center of Shenzhen Locstar Technology Co., Ltd. If you dismantle by yourself, the company does not bear any responsibility.

Appendix one

LOCSTAR[®]

Warranty card

counterfoil for customer

Product Type : _____

Product Model : _____

Date of Production : _____

Purchasing Date : _____

Purchasing Address: _____

Installation Date : _____

Purchasing Unit : _____

Name : _____

Address : _____

Zip code : _____

Phone number : _____

Thank you for your purchasing finger-print door lock of Shenzhen Locstar technology Co.,Ltd .To ensure that product plays excellent performance and makes you feel at ease and comfortable,the company offers the following services. :

Product warranty for free in 1 year.The product turns to quality problems,it shall acquire free warranty after installed and inspected by the two sides.But the man-made factors(such as the improper use,man-made damage,etc.)force majeure cause accidental damage,it does not belong to the scope ,and maintenance required charges for the cost of fees.User-demdi or without the company agree to non-designated repair sites for door locks will not gain warranty.

2、Life maintenance,Collect cost price after 1year.

3、 Shenzhen Locstar Technology Co.,Ltd.Can provide you with emergency sevicees and door-to-door services according to the selected services.

4、 If ti fails in use,Please contact with customer sevice of Shenzhen Locstar Technology Co.,Ltd .If you dismantle by yourself,the company does not bear any responsibility.

Locstar Technology Co.,Ltd

Appendix two

NO.(filled in by Manufacturer): _____

LOCSTAR®

Warranty card

counterfoil for
the factory

Product Type : _____

Product Model : _____

Date of Production : _____

Purchasing Date : _____

Purchasing Address: _____

Installation Date : _____

Purchasing Unit : _____

Name : _____

Address : _____

Zip code : _____

Phone number : _____

Please fill contents on the cards, and return it to Shenzhen Locstar Technology Co., Ltd after the installation and acceptance of 15 days, my company shall establish records for you in order to track the product life service.

Locstar Technology Co., Ltd